

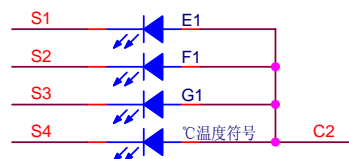

SG3016 SOP16
触摸温度检测带小数点后1位显示芯片
规格书

十位数

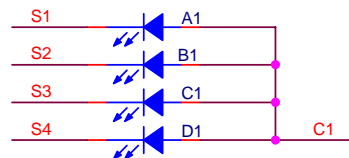

个位数

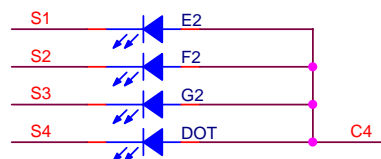
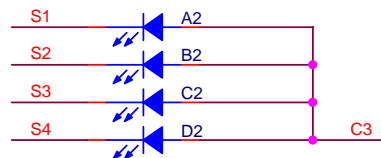

小数位

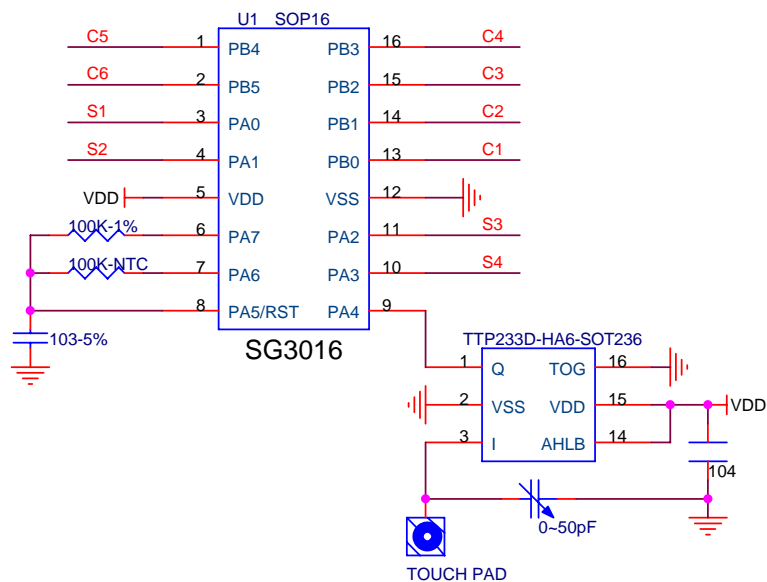
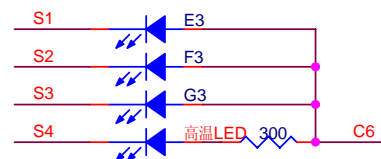
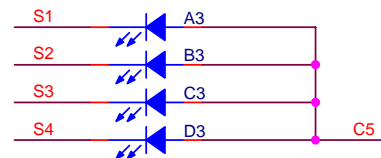

功能说明：

- 工作电压：3V
- 热敏电阻参数：100K 3950 1%
- 上电全亮后熄灭；
- 触摸显示2.5秒温度后灭；
- 检测温度范围：1-99度（带小数点后1位）

- 封装说明
(16-SOP)

